











700x750 HERKULES X-CNC 67x1,6

 mm	 a x b	 a x b				
700	750x700	750x460				
	 kW	 m/min	 mm	 kg		
3x400V 50 Hz	11,0	15-80	7680x67x1,6	10 000		
Lmin	Lmax	Bmin	Bmax	Hmin	Hmax	V
4350	5700	2010	2500	2385	2800	615



STANDARD OPTION

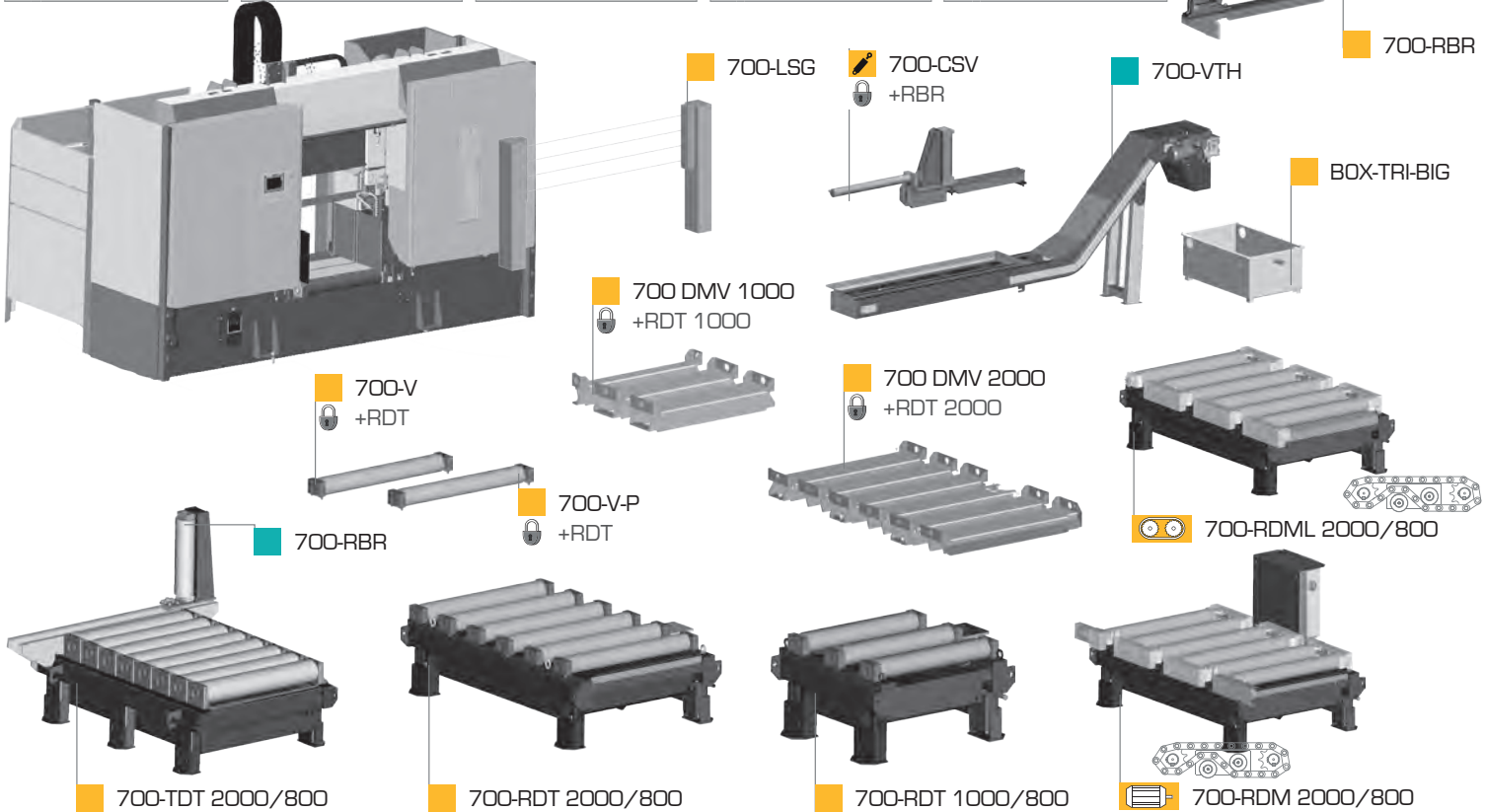
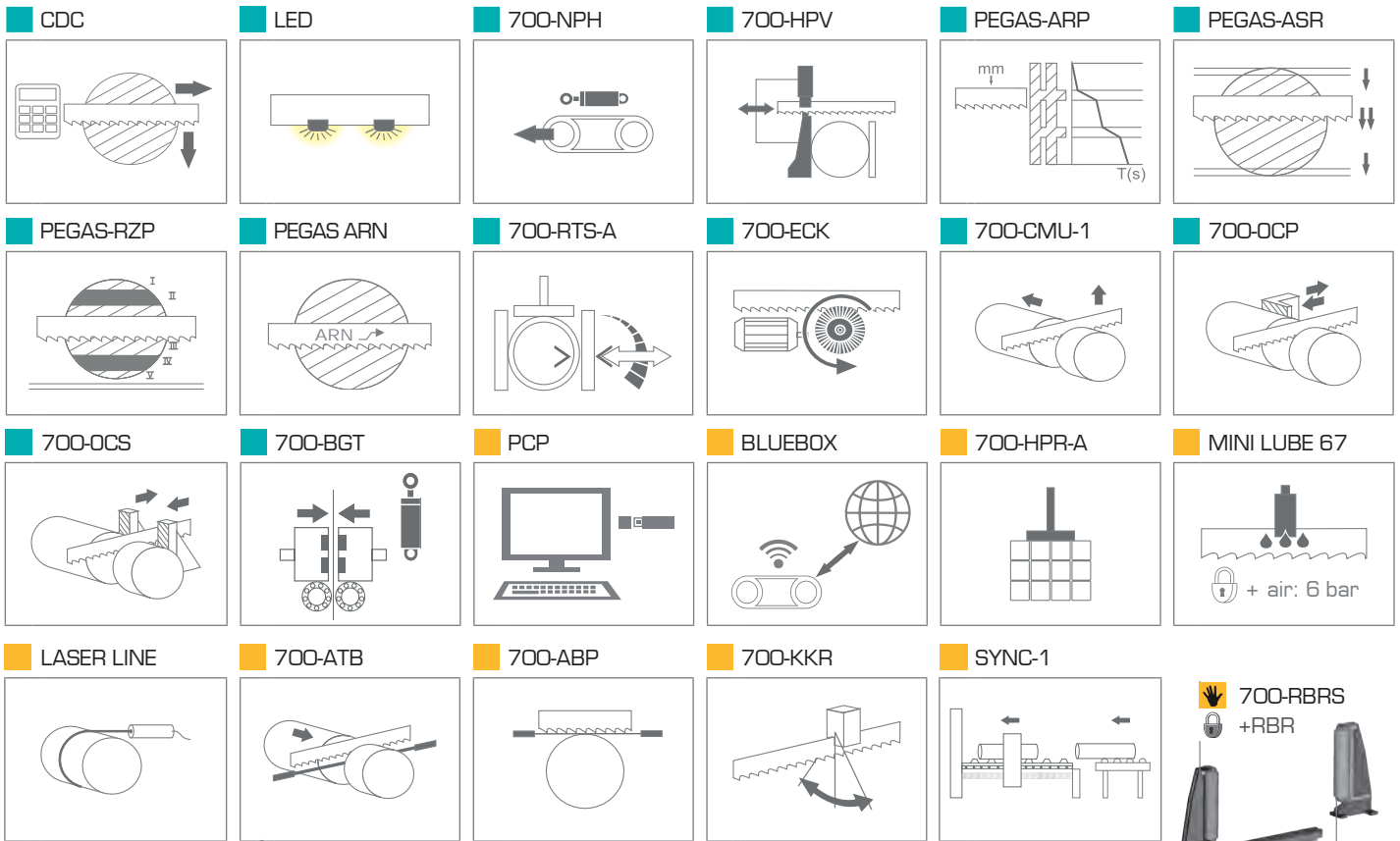

CONTROL PANEL: SIEMENS (X-CNC)

700x750 HERKULES X-CNC

- výrobce si vyhrazuje právo provádět změny technických údajů, technické údaje odpovídají 1.1.2023 / producer has the right to make changes of technical data, technical data are valid on 1.1.2023

- pila na fotografii není vždy v základním provedení, uvedené rozměry odpovídají stroji v základním provedení / the machine in the picture is not always in the basic version, mentioned diameters are for machine in basic version

* doporučená hodnota. Při překročení doporučeného maximálního průměru není možné garantovat výkon pilového pásu! / recommended value. The blade performance cannot be guaranteed when the recommended diameter is exceeded!

- řezání svazků bez horního přitlaku / cutting of the bundle without top clamping



PEGAS - GONDA s.r.o.
Čs.armády 322, 684 01 Slavkov u Brna,
CZECH REPUBLIC

www.pegas-gonda.cz
00420-544 221 125 (126) | pegas@gonda.cz